



Application

- Suitable for transferring liquids of low viscosity, non-flammable and non-explosive, not containing solid particles or fibers
- Water supply & drainage for high-rise buildings, filtration and transfer at waterworks, pressure boosting in main pipe
- Washing and cleaning systems, boiler feeding, cooling water circulation, water treatment systems, auxiliary system, support equipment
- Ultra-filtration systems, reverse-osmosis systems, distillation systems, separators, swimming pools
- Agricultural irrigation: sprinkler irrigation, drip-feed irrigation
- Food & beverage industry
- Fire-fighting system

Operating Conditions

- Low viscosity, non-flammable and non-explosive liquids not containing solid particles or fibers. The liquids must not chemically attack the pump materials. When pumping liquids with a density or viscosity is higher than that of water, a motor with a higher output power rating shall be used.
- Liquid temperature: -20°C~+120°C
- Flow ranges: 0.7-240 m³/h
- Liquid pH value: 4 - 10
- Max. ambient temperature: +40°C
- Max. operation pressure: 33 bar
- Altitude: up to 1000 m

Motor

- IE 2 motor (IE 3 motor optional)
- Totally enclosed & fan-cooled
- Protection class: IP55
- Standard voltage: 50Hz 1 × 220V/3 × 380V

Identification Codes

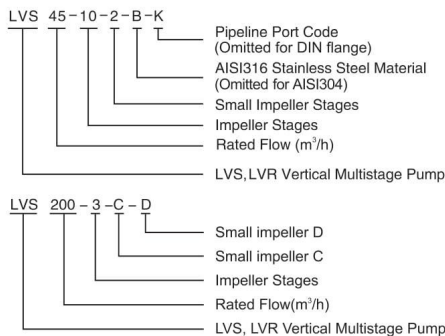

LVS: Stainless steel wetted parts

LVR: Cast iron base & pump cover

Identifications codes of flange structure

A: Oval flange; K: Clamp connector;

G: Threaded connector

Ambient Temperature

Max. ambient temperature: +40°C. Ambient temperature above 40°C or installation at altitude of more than 1000 meters above sea level require the use of an oversize motor. Because of low air density and poor cooling effects, the motor output power P₂ will be decreased. See the picture.

In such cases, it may be necessary to use a motor with a higher output power rating.

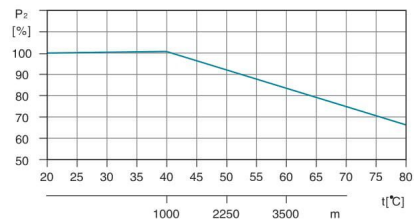

For example, when the pump is installed at altitude of more than 3500 meters above sea level, P₂ will be decreased to 88%. When the ambient temperature is 70°C, P₂ will be decreased to 78%.

Minimum Inlet Pressure-Npsh

Calculation of the inlet pressure "H" is recommended in these situations:

The liquid temperature is high.

The flow is significantly higher than the rated flow.

Water is drawn from depths.

Water is drawn through long pipes.

Inlet conditions are poor.

To avoid cavitation, make sure that there is a minimum pressure on the suction side of the pump. The maximum suction lift "H" in meters head can be calculated as follows:

$$H = P_b \times 10.2 - NPSH - H_f - H_s$$

P_b = Barometric pressure in bar. (Barometric pressure can be set to 1 bar). In closed systems, P_b indicates the system pressure in bar.

NPSH = Net Positive Suction Head in meters head. (To be read from the NPSH curve at the highest flow the pump will be delivering.)

H_f = Friction loss in suction pipe in meters head. (At the highest flow the pump will be delivering.)

H_v = Vapor pressure in meters head. (To be read from the vapor pressure scale. "H_v" depends on the liquid temperature "t_m")

H_s = Safety margin=minimum 0.5 meters head.

If the "H" calculated is positive, the pump can operate at a suction lift of maximum "H" meters head.

If the "H" calculated is negative, an inlet pressure of minimum "H" meters head is required.

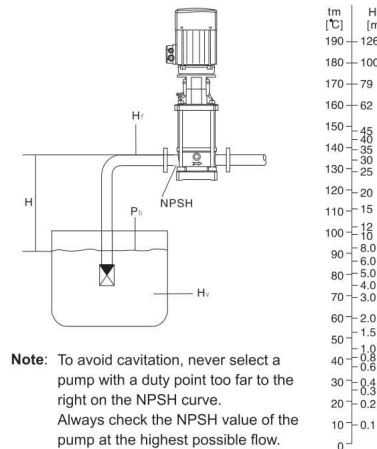

Maximum Inlet Pressure

The following table shows the maximum permissible inlet pressure. However, the current inlet pressure + the pressure against a closed valve must always be lower than the Max. permissible operating pressure.

If the maximum permissible operating pressure is exceeded, the bearing in the motor may be damaged and the life of the shaft seal reduced.

Model	Maximum Inlet Pressure [bar]
LVR1, LVS1	
1-2 — 1-36	10
LVR2, LVS2	
2-2	6
2-3 — 2-12	10
2-13 — 2-26	15
LVR3, LVS3	
3-2 — 3-29	10
3-31 — 3-26	15
LVR4, LVS4	
4-2	6
4-3 — 4-11	10
4-12 — 4-22	15
LVR5, LVS5	
5-2 — 5-16	10
5-18 — 5-29	15
LVR10, LVS10	
10-1 — 10-6	8
10-7 — 10-22	10
LVR15, LVS15	
15-1 — 15-3	8
15-4 — 15-17	10
LVR20, LVS20	
20-1 — 20-3	8
20-4 — 20-17	10
LVR32, LVS32	
32-1-1 — 32-4	4
32-5-2 — 32-10	10
32-11 — 32-14	15
LVR45, LVS45	
45-1-1 — 45-2	4
45-3-2 — 45-5	10
45-6-2 — 45-13-2	15
LVR64, LVS64	
64-1-1 — 64-2-2	4
64-2-1 — 64-4-2	10
64-4-1 — 64-8-1	15
LVR90, LVS90	
90-1-1 — 90-1	4
90-2-2 — 90-3-2	10
90-3 — 90-6	15
LVR120, LVS120	
120-1 — 120-2-1	10
120-2 — 120-5-1	15
120-5 — 120-7	20
LVR150, LVS150	
150-1-1 — 150-2-2	10
150-2-1 — 150-4-1	15
150-4 — 150-6	20
LVR200, LVS200	
200-1-D	10
200-1-C — 200-2-2C	15
200-2-C — 200-4	20

How to Read The Curve Charts

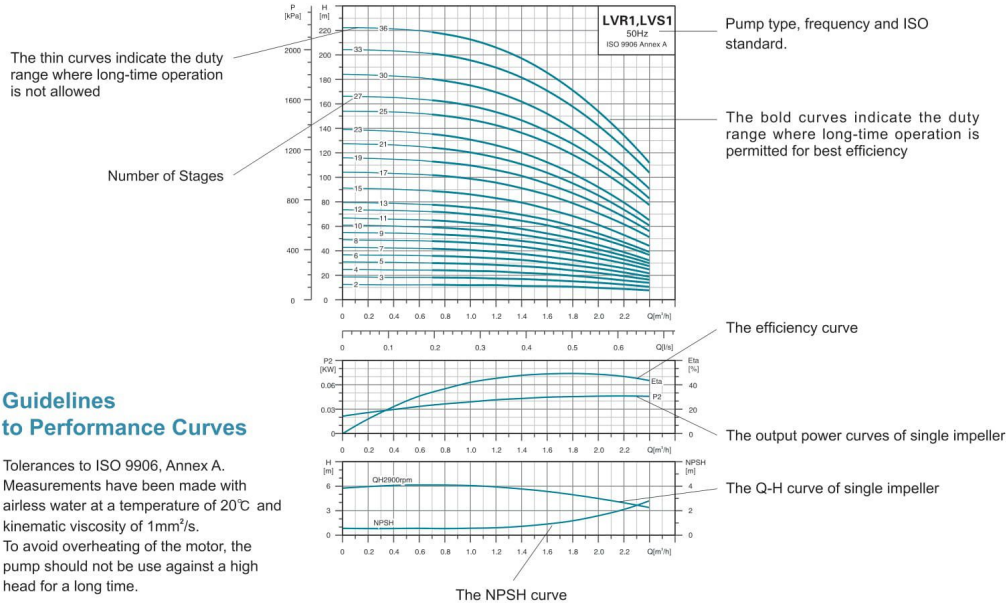

Guidelines to Performance Curves

Tolerances to ISO 9906, Annex A. Measurements have been made with airless water at a temperature of 20°C and kinematic viscosity of 1mm²/s. To avoid overheating of the motor, the pump should not be used against a high head for a long time.

Minimum Flow Rate

Due to the risk of overheating, the pump should not be used at a flow below the minimum flow rate. The curve below shows the minimum flow rate as a percentage of the nominal flow rate in relation to the liquid temperature.

Air cooling apparatus

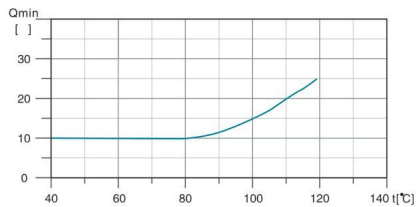

Note: The outlet valve must be opened when the pump is in operation.

Terminal Box Positions

(Note: set to position 1 before delivery)

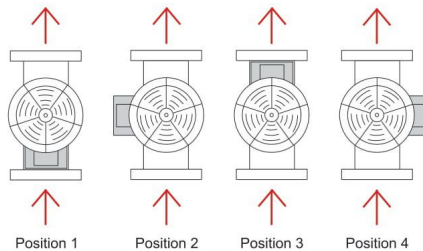

Product Range

MODEL	LVR(S)1	LVR(S)2	LVR(S)3	LVR(S)4	LVR(S)5	LVR(S)10	LVR(S)15	LVR(S)20	LVR(S)32	LVR(S)45	LVR(S)64	LVR(S)90	LVR(S)120	LVR(S)150	LVR(S)200
DESCRIPTION															
Rated flow [m ³ /h]	1	2	3	4	5	10	15	20	32	45	64	90	120	150	200
Flow range [m ³ /h]	0.7-2.4	1.0-3.5	1.2-4.5	1.5-8	2.5-8.5	5-13	8-23	10.5-29	15-40	22-58	30-85	45-120	60-150	80-180	100-240
Max. pressure [bar]	22	23	24	21	24	22	23	25	28	33	22	20	16	16	16
Motor power [kW]	0.37-2.2	0.37-3	0.37-3	0.37-4	0.37-4	1.1-7.5	1.1-15	1.1-18.5	1.5-30	3-45	4-45	5.5-45	11-75	11-75	18.5-110
Temperature Range [°C]	-20°C~+120°C (Note: Both the Max. permissible pressure and liquid temperature range refer to the pump capacity.)														
Max. pump efficiency [%]	45	46	55	59	60	65	70	72	78	79	80	81	74	73	79
Pipe connection-LVR															
Oval flange	G1	G1	G1	G1 1/4	G1 1/4	-	-	-	-	-	-	-	-	-	-
DIN flange	DN25	DN25	DN25	DN32	DN32	DN40	DN50	DN50	DN65	DN80	DN100	DN100	DN125	DN125	DN150
Pipe connection-LVS															
Oval flange	-	-	-	-	-	-	-	-	-	-	-	-	-	-	-
DIN flange	DN32	DN32	DN32	DN32	DN32	DN40	DN50	DN50	DN65	DN80	DN100	DN100	DN125	DN125	DN150
Clamp connector	φ 42	φ 42	φ 42	φ 42	φ 42	-	-	-	-	-	-	-	-	-	-
Threaded connector	G1 1/4	G1 1/4	G1 1/4	G1 1/4	G1 1/4	-	-	-	-	-	-	-	-	-	-

Scope of Performance-LVR,LVS

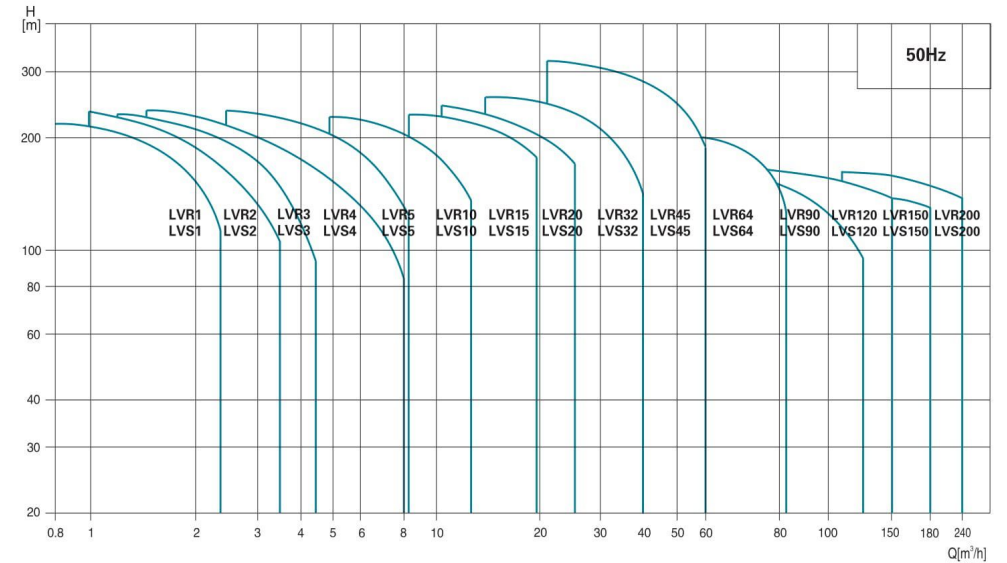

Cross Section

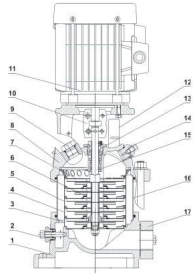

MODEL: LVR1 (2,3,4,5)

Part	Material
1 Base	HT200
2 Drainage plug assembly	AI31304
3 Primary diffuser	AI31304
4 Diffuser with bearing	AI31304
5 Medium diffuser	AI31304
6 Impeller	AI31304
7 Final volute	AI31304
8 Motor base	HT200
9 Filling plug	AI31304
10 Coupling	Iron based powder metallurgy
11 Motor	
12 Guarding plate	AI31304
13 Cartridge seal	
14 Vent plug assembly	AI31304
15 Pump shaft	AI31304
16 Pump barrel	AI31304
17 Oval flange	HT200

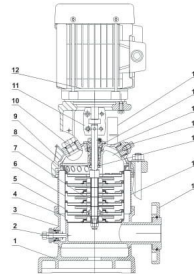

MODEL: LVS1 (2,3,4,5)

Part	Material	Optional Material
1 Base plate	HT200	
2 Drainage plug assembly	AI31304	AI31316
3 Chassis	ZG304	ZG316
4 Primary diffuser	AI31304	AI31316
5 Diffuser with bearing	AI31304	AI31316
6 Medium diffuser	AI31304	AI31316
7 Impeller	AI31304	AI31316
8 Final volute	AI31304	AI31316
9 Motor base	HT200	
10 Filling plug	AI31304	AI31316
11 Coupling	Iron based powder metallurgy	
12 Motor		
13 Guarding plate	AI31304	
14 Cartridge seal		
15 Pump cover	ZG304	ZG316
16 Vent plug assembly	AI31304	AI31316
17 Pump shaft	AI31304	AI31316
18 Pump barrel	AI31304	AI31316
19 Flange	ZG35	

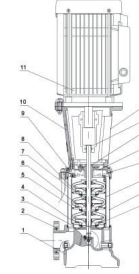

MODEL: LVR32 (45,64,90)

Part	Material
1 Base plate	HT200
2 Flange	ZG35
3 Primary diffuser	AI31304
4 Medium diffuser	AI31304
5 Diffuser with bearing	AI31304
6 Impeller	AI31304
7 Shaft sleeve assembly	
8 Final diffuser	AI31304
9 Vent plug assembly	AI31304
10 Motor base	HT200
11 Motor	
12 Guarding plate	AI31304
13 Coupling	QT400
14 Cartridge seal	
15 HT200 Pump head	HT200
16 Filling plug	AI31304
17 Tension plate	AI31304
18 Pump barrel	AI31304
19 Pump shaft	AI31304

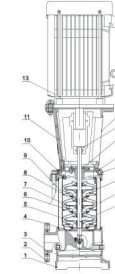

MODEL: LVS32 (45,64,90)

Part	Material	Optional Material
1 Base plate	HT200	
2 Flange	ZG35	
3 Chassis	ZG304	ZG316
4 Primary diffuser	AI31304	AI31316
5 Medium diffuser	AI31304	AI31316
6 Diffuser with bearing	AI31304	AI31316
7 Impeller	AI31304	AI31316
8 Shaft sleeve assembly		
9 Final diffuser	AI31304	AI31316
10 Vent plug assembly	AI31304	AI31316
11 Motor base	HT200	
12 Motor		
13 Guarding plate	AI31304	
14 Coupling	QT400	
15 Cartridge seal		
16 Pump head	ZG304	ZG316
17 Filling plug	AI31304	AI31316
18 Tension plate	AI31304	AI31316
19 Pump barrel	AI31304	AI31316
20 Pump shaft	AI31304	AI31316

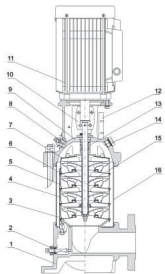

MODEL: LVR10 (15,20)

Part	Material
1 Base	HT200
2 Drainage plug assembly	AI31304
3 Primary diffuser	AI31304
4 Diffuser with bearing	AI31304
5 Medium diffuser	AI31304
6 Impeller	AI31304
7 Final volute	AI31304
8 Filling plug	AI31304
9 Motor base	HT200
10 Coupling	Iron based powder metallurgy
11 Motor	
12 Guarding plate	AI31304
13 Cartridge seal	
14 Vent plug assembly	AI31304
15 Pump shaft	AI31304
16 Pump barrel	AI31304

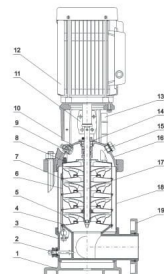

MODEL: LVS10 (15,20)

Part	Material	Optional Material
1 Base plate	HT200	
2 Drainage plug assembly	AI31304	AI31316
3 Chassis	ZG304	ZG316
4 Primary diffuser	AI31304	AI31316
5 Diffuser with bearing	AI31304	AI31316
6 Medium diffuser	AI31304	AI31316
7 Impeller	AI31304	AI31316
8 Final volute	AI31304	AI31316
9 Filling plug	AI31304	AI31316
10 Motor base	HT200	
11 Coupling	Iron based powder metallurgy	
12 Motor		
13 Guarding plate	AI31304	
14 Cartridge seal		
15 Vent plug assembly	AI31304	AI31316
16 Pump cover	ZG304	AI31316
17 Pump shaft	AI31304	AI31316
18 Pump barrel	AI31304	AI31316
19 Flange	ZG35	

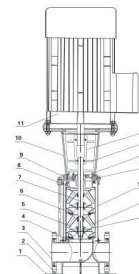

MODEL: LVR120 (150,200)

Part	Material
1 Base plate	HT200
2 Flange	ZG35
3 Base	HT200
4 Primary diffuser	AI31304
5 Medium diffuser	AI31304
6 Diffuser with bearing	AI31304
7 Impeller	AI31304
8 Final diffuser	AI31304
9 Pump head	HT200
10 Motor base	HT200
11 Motor	
12 Coupling	QT400
13 Guarding plate	AI31304
14 Cartridge seal	
15 Filling plug	AI31304
16 Tension plate	AI31304
17 Pump barrel	AI31304
18 Pump shaft	AI31304

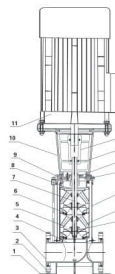

MODEL: LVS120 (150,200)

Part	Material	Optional Material
1 Base plate	HT200	
2 Flange	ZG35	
3 Chassis	ZG304	ZG316
4 Primary diffuser	AI31304	AI31316
5 Medium diffuser	AI31304	AI31316
6 Diffuser with bearing	AI31304	AI31316
7 Impeller	AI31304	AI31316
8 Final diffuser	AI31304	AI31316
9 Pump head	ZG304	ZG316
10 Motor base	HT200	
11 Motor		
12 Coupling	QT400	
13 Guarding plate	AI31304	
14 Cartridge seal		
15 Filling plug	AI31304	AI31316
16 Tension plate	AI31304	AI31316
17 Pump barrel	AI31304	AI31316
18 Pump shaft	AI31304	AI31316

Hydraulic Performance Curves

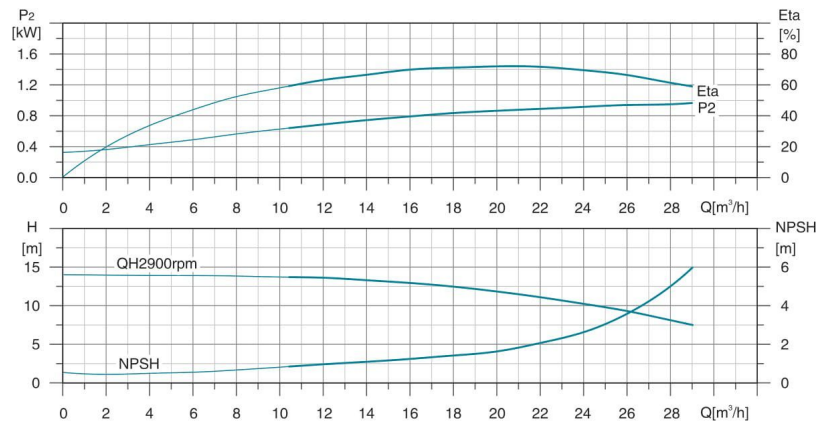
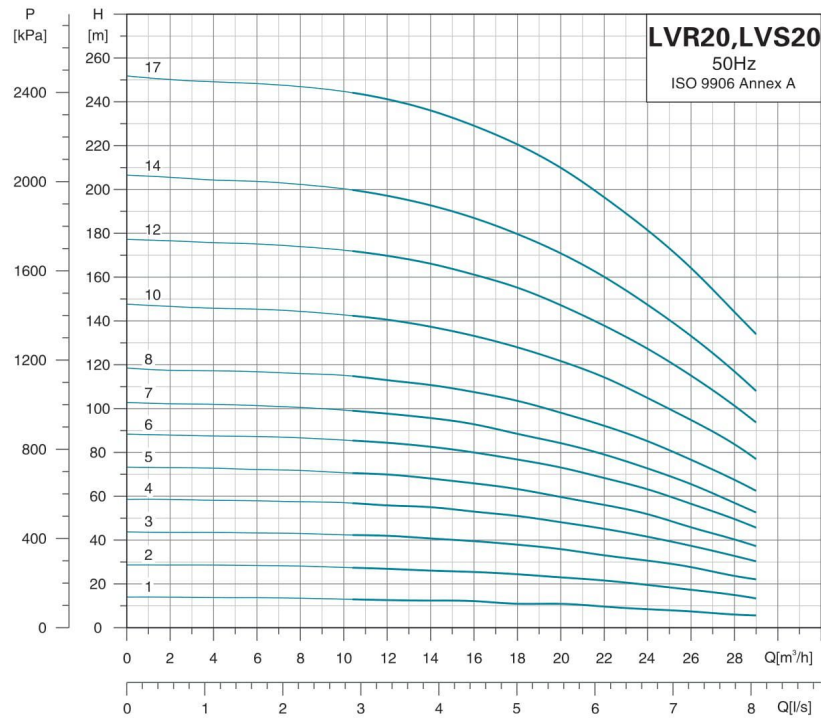

Dimension Drawing

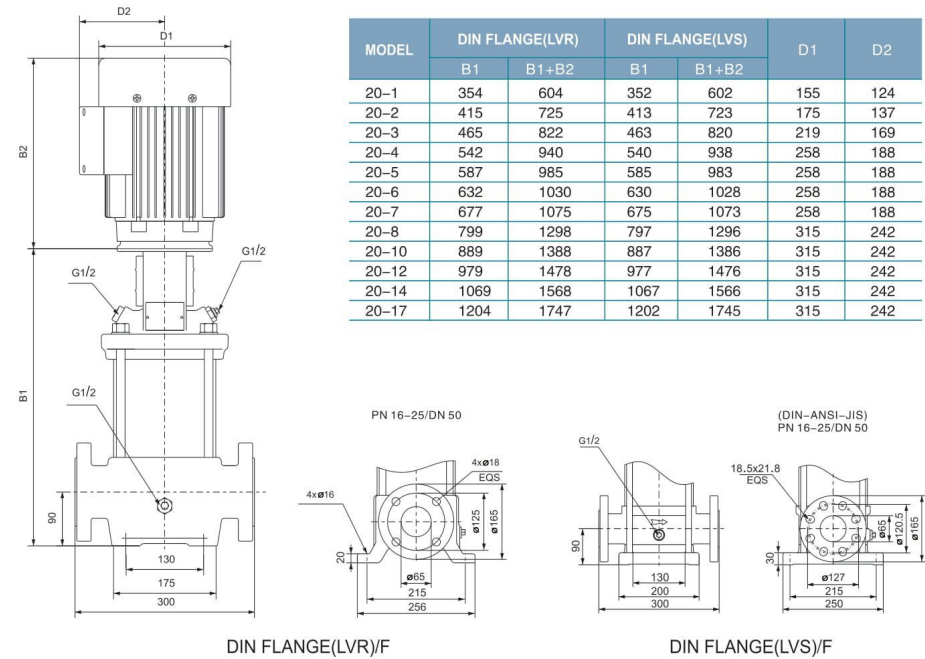

MODEL	DIN FLANGE(LVR)		DIN FLANGE(LVS)		D1	D2
	B1	B1+B2	B1	B1+B2		
20-1	354	604	352	602	155	124
20-2	415	725	413	723	175	137
20-3	465	822	463	820	219	169
20-4	542	940	540	938	258	188
20-5	587	985	585	983	258	188
20-6	632	1030	630	1028	258	188
20-7	677	1075	675	1073	258	188
20-8	799	1298	797	1296	315	242
20-10	889	1388	887	1386	315	242
20-12	979	1478	977	1476	315	242
20-14	1069	1568	1067	1566	315	242
20-17	1204	1747	1202	1745	315	242

MODEL	POWER[kW]	Q[m³/h]	4	8	12	16	20	24	28
20-1	1.1	H(m)	13	13	13	12	10.5	9.5	6.5
20-2	2.2		28	28	27	25	22.5	19	15
20-3	4.0		43	43	42	39	36	30	23
20-4	5.5		58	57	56	53	48	41	32
20-5	5.5		73	72	70	66	60	52	40
20-6	7.5		87	83	84	80	72	62	49
20-7	7.5		102	100	97	93	84	72	57
20-8	11.0		117	116	113	107	96	85	67
20-10	11.0		146	144	140	132	120	105	83
20-12	15.0		175	174	169	161	144	127	101
20-14	15.0		204	202	197	187	168	147	117
20-17	18.5		249	247	241	229	205	181	144